

OWNER'S MANUAL

Download this Manual at: v1gen2.info/manual



 **valentine**  **Gen2 One™**
———— *RADAR LOCATOR*

With exclusive Analyzer Modes:

- **All-Bogeys®**
- **Logic®**
- **Advanced-Logic®**

SAW D²L powered



Contents

Welcome to Full Coverage	
Full Coverage	1-2
What's Included	3
Controls and Functions.....	4
Mounting — Where and How.....	5
How to connect to 12V, USB jack.....	5
How to connect a headphone	6
How to set Muted Volume	6
Display readings.....	6
How to set Analyzer Modes.....	7
How to get our free app.....	7
How to connect to your phone.....	7
Lighter Adapter.....	8
Installation — Direct-Wire Power Adapter	8
Changing the Fuse	9
Concealed Display	10
Installation — Concealed Display.....	11
Tech Display.....	12-13
SAVVY.....	14-15
POP Mode.....	16
What you should know about radar.....	17-20
Finding Radar — On-the-Road Situations	21-24
Laser Warning	25
What you should know about laser	26
Finding Laser	27
Troubleshooting.....	28-29
Doubts — Maybe it's not working right.....	30
Service	31
Upgrades.....	32
Specifications	32
Parts and Accessories.....	33
Limited Warranty	34
FCC and CE Regulatory Information	35
A Few Things To Remember	36

Welcome to Full Coverage

Dear V1 Owner:

When an interest lasts for a year or two, that's a hobby. When it goes on more than half a lifetime, that's an obsession.

I can't help it. Designing black boxes to sniff out ever fainter radar and laser signals is, to me, the most interesting game on the planet. This is a civilian version of what the military calls Electronic Warfare Support Measures (ESM). Think of it as cat-and-mouse out to ten decimal places.

The goal is always the same—Range Superiority.

At the beginning of the Valentine One® Generation 2 project, I told my engineers, "We want the best radar-seeking engine this side of the military." In fact, we adapted a component from military CHIRP radars—used to find fainter targets farther away with higher precision—a SAW Dispersive Delay Line (SAW-D2L). For civilian users, V1 Gen2™ is a breakthrough on range.

Since starting my own company back in the 1980s, we've always walked our own path. We invented the Radar Locator and the Bogey Counter, two essential must-knows when sizing up radar threats.

We're unique in another way, too. We don't do annual model changes, and we don't offer an array of models to pick off every price point. Instead, we offer only one model—the best detector we know how to build. And to keep V1 Gen2 the best, we practice continuous improvement; that means every performance enhancement the engineering department works up will be available to you as a smartphone download.

Thanks for choosing us to be your radar-and-laser-detector company.

Sincerely,



Michael D. Valentine



▲ Mike Valentine: Electronics engineer, inventor of the radar-locating detector, over four decades making and selling high-performance detectors.

What Full Coverage means for you

Finds all radars

Valentine One Gen2 covers all four bands:

X band.....moving and stationary; can be used in instant-on mode; this frequency is shared with burglar alarms and door openers.

◀ **X band**
10.500–10.550 GHz

K band.....moving and stationary; can be used in instant-on mode; this frequency is shared with burglar alarms and door openers.

◀ **K band**
24.050–24.250 GHz

Ka band.....widest of the radar bands; moving and stationary; can be used in instant-on mode; fewer false alarms than X and K though some can be caused by poorly-made radar detectors.

◀ **Ka band**
33.4–36.0 GHz

Photo radar.....K or Ka band.

POP Protection.....covers POP mode on two bands—specifically MPH Industries models BEE III and Enforcer on both K and Ka; moving or stationary.

Ku band.....Not used in the U.S.; standard equipment on all V1 Gen2s, but not activated at the factory. To activate, see <https://www.valentine1.com/programming/>.

◀ **Ku band**
13.400–13.500 GHz

Euro Mode.....Not to be used in the U.S.; This widens K-band reception to assure coverage of the new Multiradar being used abroad. Standard equipment on all V1 Gen2s, but not activated at the factory. To activate, see <https://www.valentine1.com/programming/>.

◀ **Euro Mode**
23.900-24.250GHz

Finds all lasers

Valentine One Gen2 finds all traffic lasers. In the U.S., the operating wavelength of traffic laser is 820-950 nanometers

◀ **Laser**
820-950 nanometers

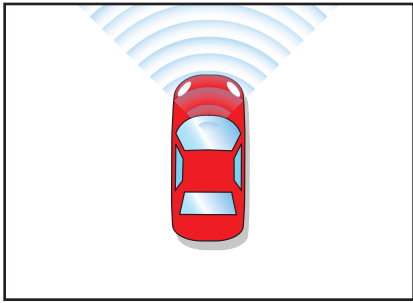

Ordinary detectors scan ahead of your car only.

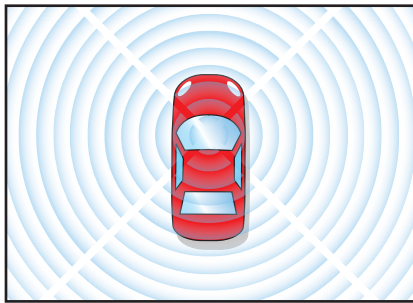

V1 Gen2 scans all around your car.

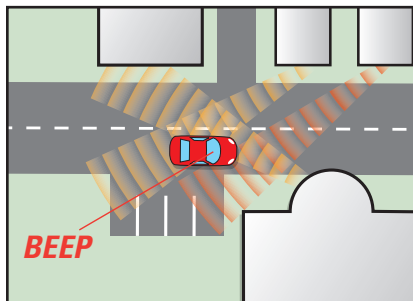

Ordinary detectors give the same warning for one or multiple radar signals.

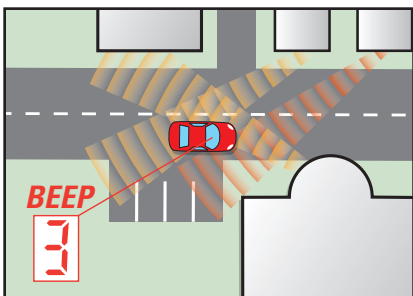

V1 Gen2 counts threats so you'll never be surprised.

Tells Where

Valentine One Gen2 has an advanced version of the Radar Locator we invented for Valentine One. A red arrow points to the radar source, either ahead of you, beside you, or behind you. Please note: radar can't get you from the side.



Radar ahead



Radar to the side



Radar behind

Valentine One Gen2 also locates the laser source, either ahead or behind. Like radar, laser can't get you from the side.

Tells How Many

Valentine One Gen2 tracks all threats (bogey). How many are out there? Consider:

Example 1: Let's say your detector is in full alert, then you see a radar unit. Naturally you assume the radar you saw is the cause of the alert. But what if there's a second radar unit just up the road waiting for you?

Example 2: Let's say you're in an alert caused by a known X-band burglar alarm. What if a radar operator, using instant-on, is simultaneously working the same territory?

In both cases, an ordinary radar detector would have set you up for a big surprise because it would lead you to believe that only one bogey was out there. But the Bogey Counter on V1 Gen2 counts every signal being tracked at all times. It's your insurance against surprises.

Anything less is not Full Coverage!

What's Included

With Valentine One Gen2 Radar Locator:

1. Valentine One Gen2 Radar Locator
2. Windshield mount
3. Visor mount
4. Lighter Adapter
5. Power cord, coiled
6. Power cord, straight
7. Spare suction cups
8. Direct-Wire Power Adapter
9. Wiring-harness connector
10. Quick Start Guide
11. Spare fuse

With the optional-at-extra-cost Concealed Display:

1. Straight power cord, 8-foot
2. Straight power cord, 3.5-inch
3. Display-module backplate, for mounting
4. Self-stick interlocking fasteners

With the optional-at-extra-cost SAVVY:

1. Two wire clips
2. Beaded tie strap

With the optional-at-extra-cost Tech Display:

1. Straight power cord, 8-foot
2. Self-stick interlocking fasteners

Controls and Functions

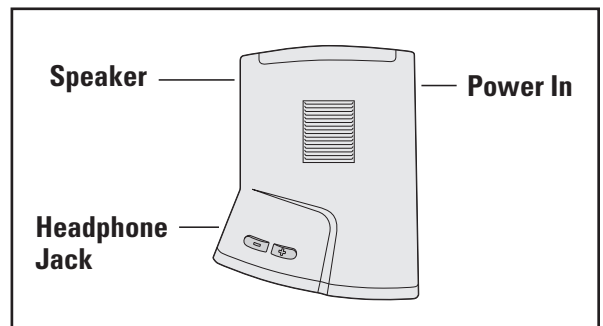
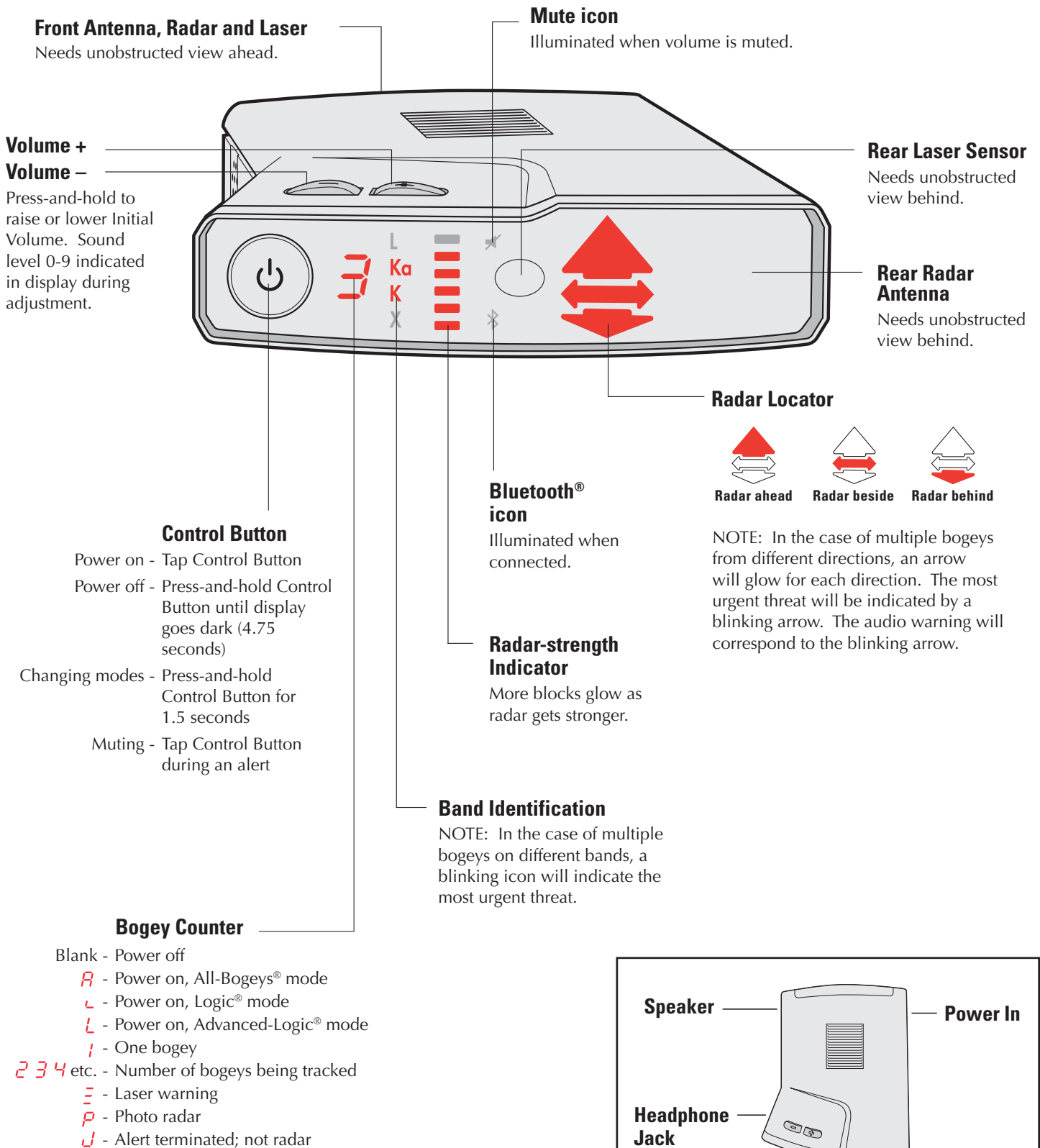

How to mount

Using one of the supplied mounts, starting from the front-antenna end of the detector, slide it into the mounting grooves on each side of the detector. Position the detector so the front antenna looks through the windshield and the rear antenna has a clear view to the rear of your car. Stay clear of the wipers and the dark mask at the top of the glass.

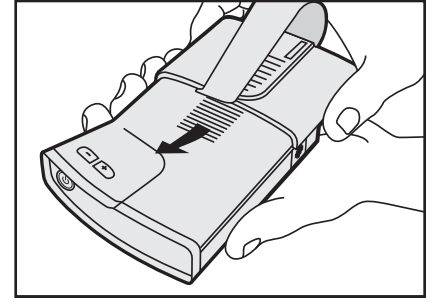

Visor mount slides on from the front.

When the detector is properly oriented, the driver will see this view. ►

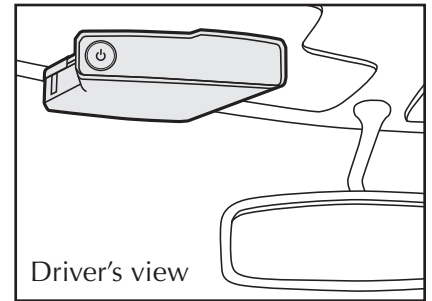

Install near center of windshield.

Safety Warning

Because a detector on a windshield mount or a visor mount is not permanently attached to the car, it could come loose in a crash, possibly causing injury. Also, a passenger may move forward on impact and contact the detector. Keep these possibilities in mind when you mount your Valentine One Gen2.

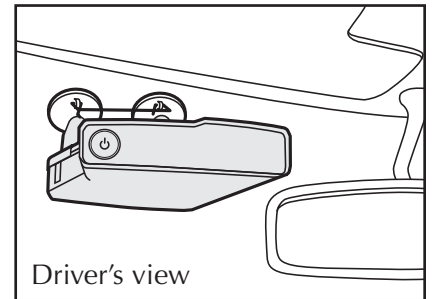

Install near center of windshield.

How to connect to 12V

Plug one end of the supplied power cords into the detector's RJ11 jack. Plug the other end into the Lighter Adapter jack marked "MAIN" and insert the adapter into the car's 12V socket. If your vehicle has only a USB socket, you'll need to purchase a USB-to-12V Converter.

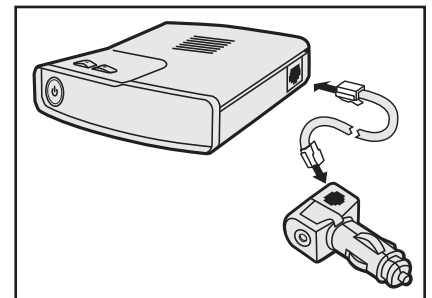





Plug in one end of the power cord into V1 Gen2's RJ11 jack. Plug the other end into the Lighter Adapter.

How to connect a headphone

Plug headphone jack into the detector's 3.5mm socket. For Bluetooth headphones, connect through **V1connection, the app**.

How to set Muted Volume

Muted Volume is the sound level you hear after Muting. To adjust, tap the  or  to start the test tone. Tap the Control Button to enter the Mute mode (Mute icon will appear). Then press  or  until you've reached your preferred sound level. Sound level 0-9 indicated in display during adjustment.

Display readings

1. If the display is dark:
 - a) Power is off, or;
 - b) A Concealed Display is connected, or;
 - c) Dark Mode has been enabled in the app.
2. With power on, in the absence of alerts, the current Mode will be displayed.
3. During alerts:
 - a) The Mode indication will be replaced by the Bogey Count (number of radar signals in range).
 - b) Signal strength indicated by a vertical bar graph.

How to set Analyzer Modes

With power on in the absence of an alert, press-and-hold the Control Button repeatedly to step through the three available Analyzer Modes.

- **In All-Bogeys mode** **A**, all bogeys will be reported at the Initial Volume as soon as they are detected. Use your judgment to decide whether or not they are threats.
- **In Logic mode** **L**, X- and K-band bogeys assessed to be too weak to be threats will be reported at the Muted Volume. If and when they become threats, the audio warning will increase to the Initial Volume.
- **In Advanced Logic mode** **L**, X- and K-band bogeys the Analyzer determines are not threatening will not be reported at all. Threats will be reported at Initial Volume. This mode is particularly useful in metro areas. One exception: to be failsafe, the Analyzer will always pass extremely strong alerts along to you for your judgment.

NOTE: In Logic mode **L** and Advanced Logic mode **L**, you are deferring to an algorithm that will assess the threat level and report accordingly.

Be assured that the Analyzer has years of radar experience. It always operates the receiving circuitry at maximum sensitivity, and it knows that instant-on radar is a greater threat than ordinary radar. Therefore it will always warn of instant-on immediately at the Initial Volume whenever it is detected.

How to get our free app

Go to your app store and download **V1connection, the app**.

How to connect V1 Gen2 to your phone

The first time **V1connection the app** is run, it will automatically connect if it finds only one V1 Gen2. Subsequently, it will connect to the first V1 Gen2 it recognizes. If none of them are the last one used, it will automatically connect to the first one found. If it finds more than one, you will be prompted to select which to use. Select the V1 Gen2 with the highest (least negative) RSSI value from the list. V1 Gen2's blue **✱** will change to a constant glow when connected.

NOTE: The V1 Gen2 will not be shown in the list of Bluetooth devices on your iPhone, iPad or iPod touch.

Lighter Adapter

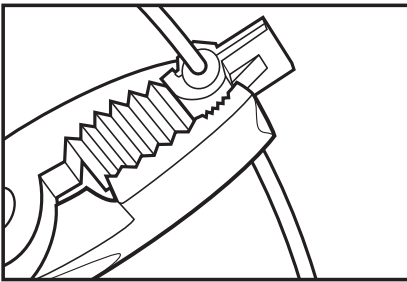
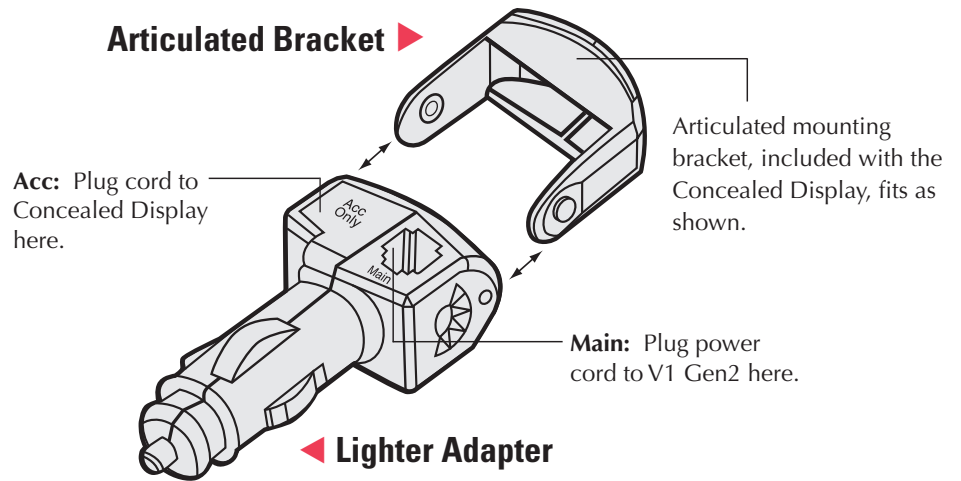

Pinch connector around power wire.

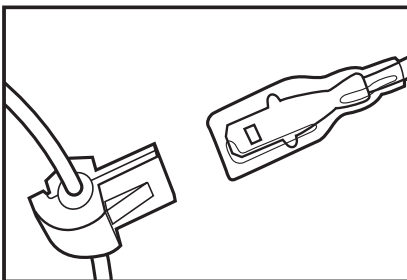

Connector plugs into red wire.

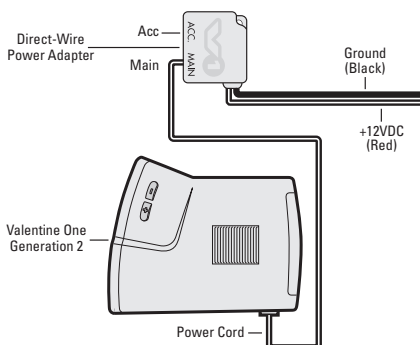

INSTALLATION: Direct-Wire Power Adapter

An adapter has been provided so that you can wire Valentine One Gen2 directly into your car's electrical system. If you are unfamiliar with automotive electrical systems, see a mechanic or car-stereo installer:

1. Valentine One Gen2 works only with negative ground electrical systems. If your car is old, or is an unusual brand of import, make sure it's negative ground.
2. Select a "switched" wire, i.e., one that's off when the ignition is switched off, and has 12 volts when the ignition is switched on.
3. Position wiring-harness connector around "switched" wire and squeeze with pliers to install.
4. Plug red wire from Direct-Wire Power Adapter into wiring-harness connector.
5. Make ground connection by clamping the end of the black wire under any grounded screw.
6. Plug power cord from Valentine One Gen2 into the modular jack labeled "Main" on the Direct-Wire Power Adapter.

Changing the Fuse

Changing the Lighter Adapter Fuse

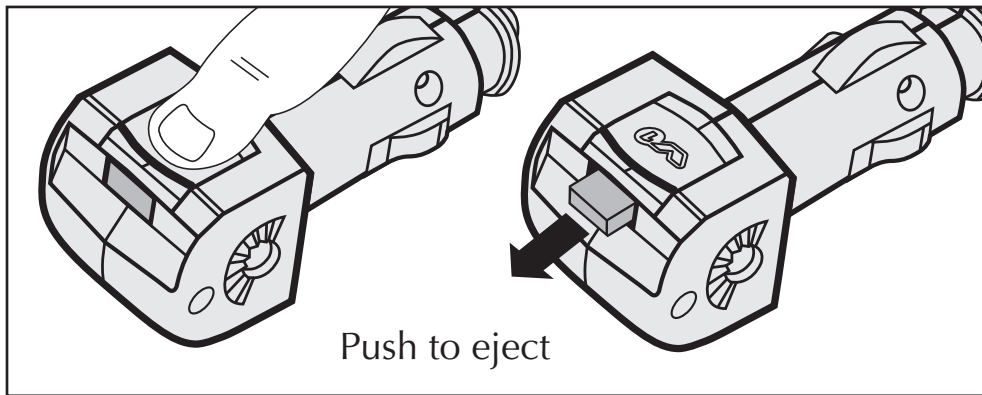

Adapters using 2-amp Mini Blade Fuse

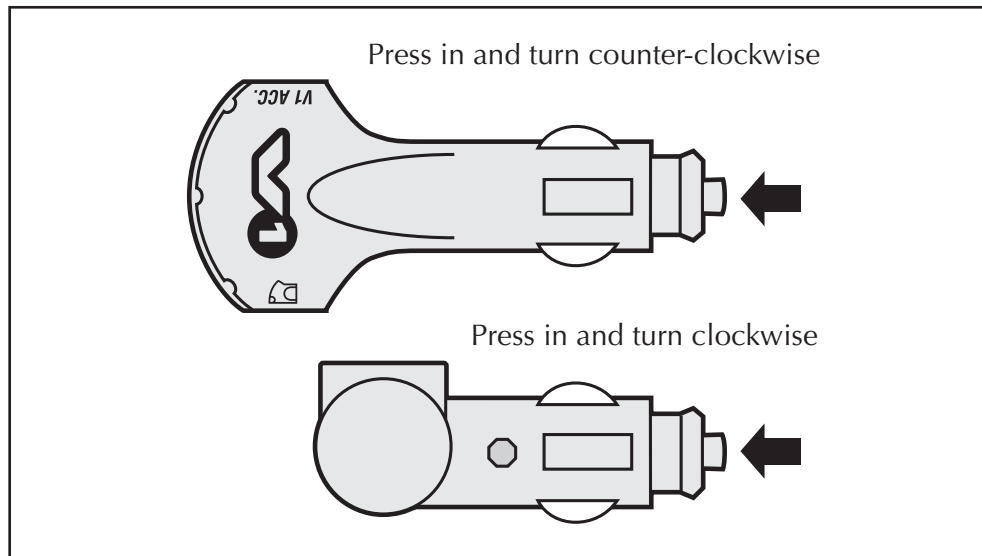

Adapters using 1-amp 5mm x 20mm fuse

Changing the Direct-Wire Power Adapter Fuse

The fuse holder is in line with the power wire (red) to the Adapter. Lift the fuse cover from the body of the fuse holder. A twisting motion may help, or pry gently at the parting line with a thin tool, such as a small screwdriver. Unplug the fuse. Replace with a 2-amp. Mini Blade fuse.

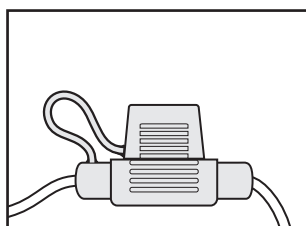

In-line fuse holder.

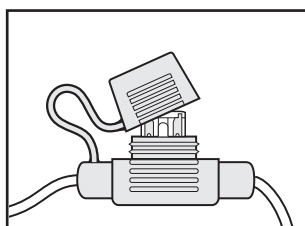

Lift cover.

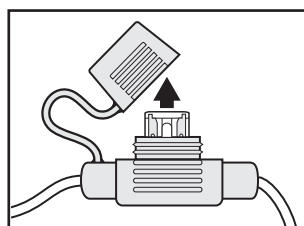

Unplug fuse.

Concealed Display

The Concealed Display (optional) makes Valentine One Gen2 less noticeable to others outside your car. It allows you to operate Valentine One Gen2 with its lights blacked out, yet have a fully operational display module down low in the car where it's not visible outside.

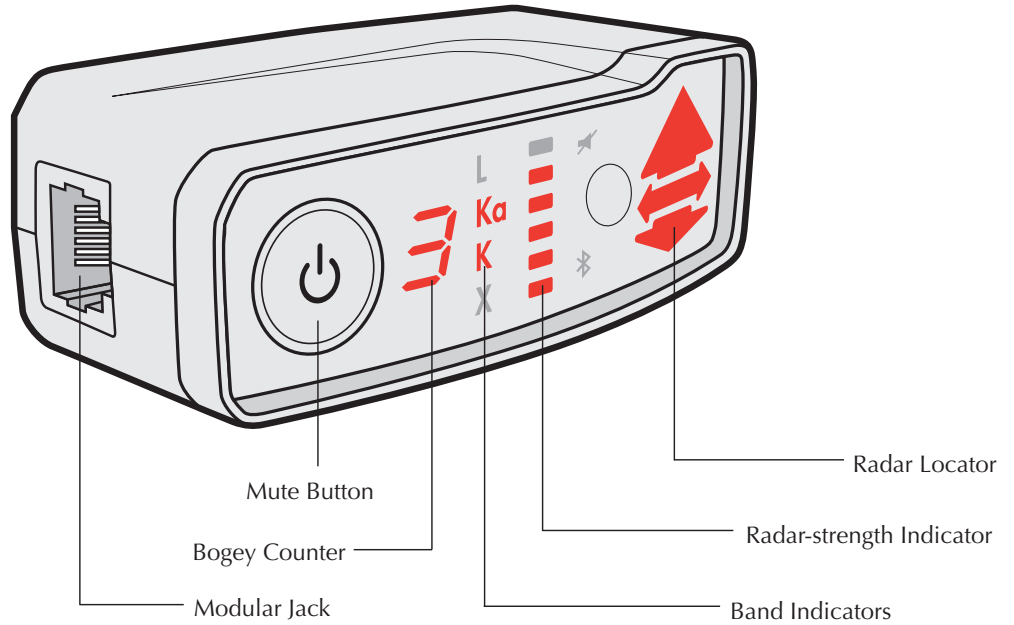

Dimensions: 1.0-in. H x 3.0-in. W x 1.4-in. D
25.4-mm H X 76.2-mm W X 35.6-mm D

INSTALLATION: Using Lighter Adapter

1. Slide Lighter Adapter with Articulated Bracket into cavity on back of Concealed Display.
2. Connect Acc on Lighter Adapter to Concealed Display with 3.5-inch cord.
3. Adjust angle on Lighter Adapter, then insert Lighter Adapter into lighter socket.
4. Run the power cord from the Main jack on the Lighter Adapter to Valentine One Gen2.
5. To operate, set volume and your choice of Analyzer Modes on Valentine One Gen2 (see instructions on pages 4 and 7).

IMPORTANT NOTE:

Do not use Direct-Wire Power Adapter with Lighter Adapter.

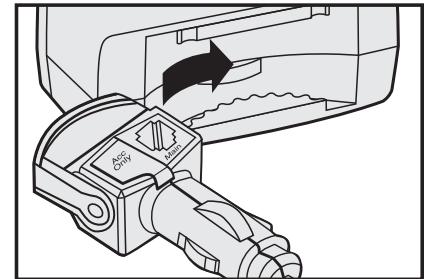
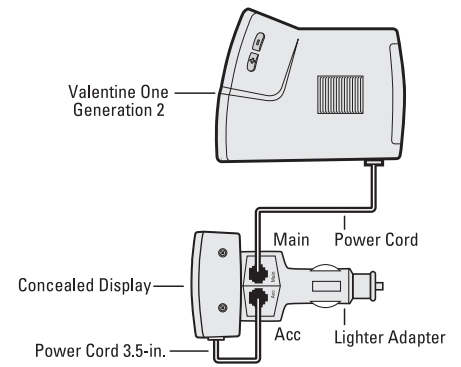

Lighter Adapter slides into place.

INSTALLATION: Using Mounting Plate

1. Slide Mounting Plate into cavity on back of Concealed Display.
2. If using self-stick interlocking fasteners, adhere one square of self-stick interlocking fasteners to the recess on the back of the Mounting Plate. Adhere mating self-stick interlocking fasteners square to desired mounting location.
3. If using the Direct-Wire Power Adapter, follow instructions on page 8.
4. Run a power cord from the Acc jack on the Lighter Adapter, or the Accessory jack on the Direct-Wire Power Adapter, to the Concealed Display.
5. Run a power cord from Main jack on the Lighter Adapter, or the Main Unit jack on the Direct-Wire Power Adapter, to Valentine One Gen2.
6. To operate, set volume and your choice of Analyzer Modes on Valentine One Gen2 (see instructions on pages 4 and 7).

IMPORTANT NOTE:

Do not use Lighter Adapter with Direct-Wire Power Adapter.

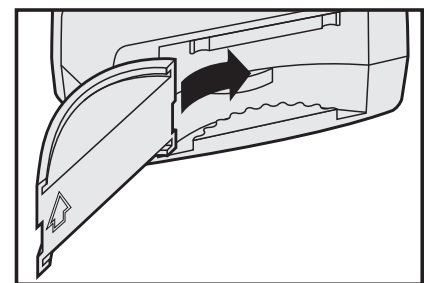
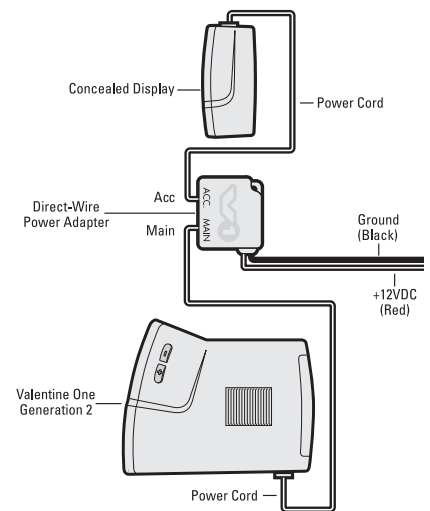

Mounting plate slides into place.

Tech Display

The Tech Display is an add-on module that informs you of the radar frequency for every alert; in the case of multiple simultaneous alerts, the display frequency will be that of the most threatening source, also called the priority alert. The Tech Display provides additional information beyond V1 Gen2's usual Radar Locator and Band ID information.

The Tech Display features a five-digit frequency readout. Why is this useful? Because for any given encounter, frequency acts as the fingerprint of the radar transmitting the beam. With this information you can track individual radars in complex encounters, or just distinguish your local enforcer from the county sheriff or state patrol.

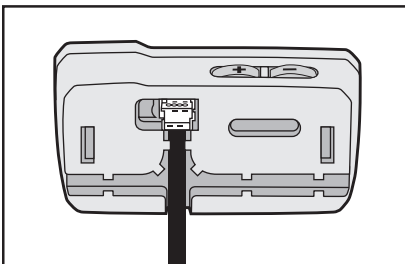
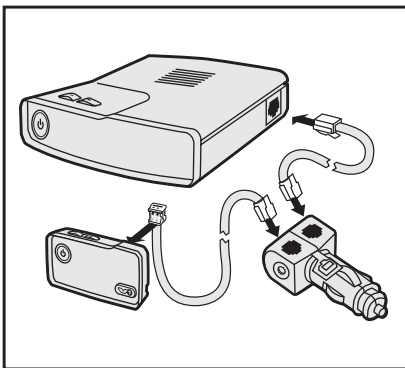

To install, use the included cord to connect to the ACC jack of the Lighter Adapter.

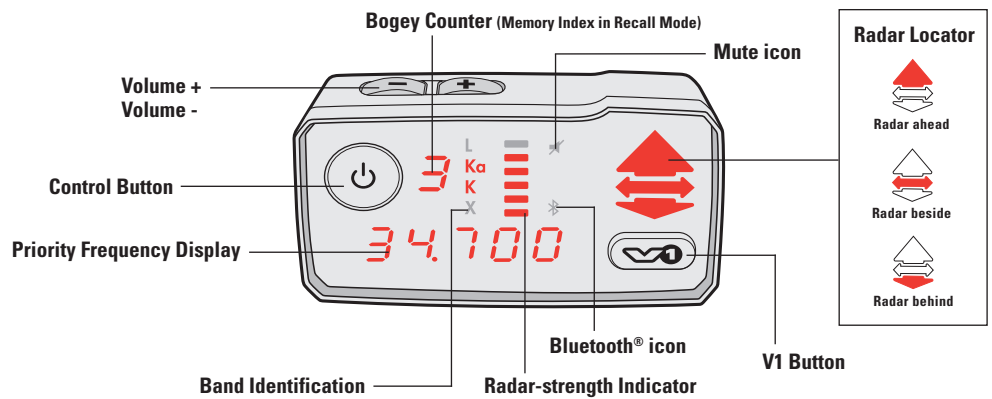

Examples of its usefulness

When radar encounters occur at the outer fringes of range, they have an on-again, off-again quality about them. Is it always the same radar that comes back or are there different enforcers out there? When you know the frequency of the alert, that question answers itself.

Perhaps you're passing through a zone of multiple alerts, the stationary sources soon drop out of range behind you. But you notice one radar that doesn't drop out, it keeps tracking along with you mile after mile. Keep watching that one.

V1 is detecting short come-and-go signals. Is the frequency always the same? If so, that could be instant-on radar zapping other traffic. You could be next. Stay at full alert until you're confident it's gone out of range.

The Tech Display's memory operates flight-recorder style, holding the last ten priority alerts in the order that you saved them. After that, saving another priority alert drops the oldest one from the memory. Information saved for each priority alert includes: band ID, signal strength, direction, and frequency. You can cycle up or down through the saved alerts by first pressing the V1 button, then the volume-up or volume-down button.

Though the Tech Display can be connected to either V1 Gen1 with ESP or V1 Gen2, for full function you'll need V1 Gen2 with the latest firmware upgrade. Find out more about firmware upgrades [here](#).

The Tech Display measures 1.7-in. H x 3.0-in. W x 0.7-in. D and weighs 1.3 ounces. Satin-black finish matches V1 Gen2. Includes: power cord, 8-ft.; self-stick interlocking fasteners.

Frequencies that matter

K Band

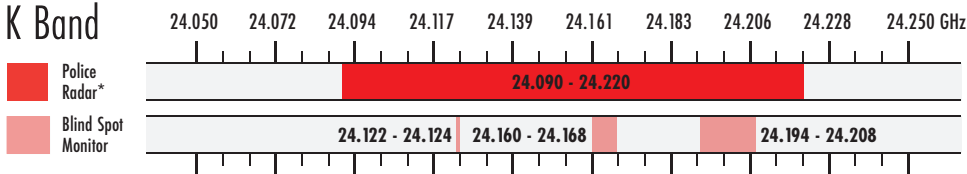

Ka Band

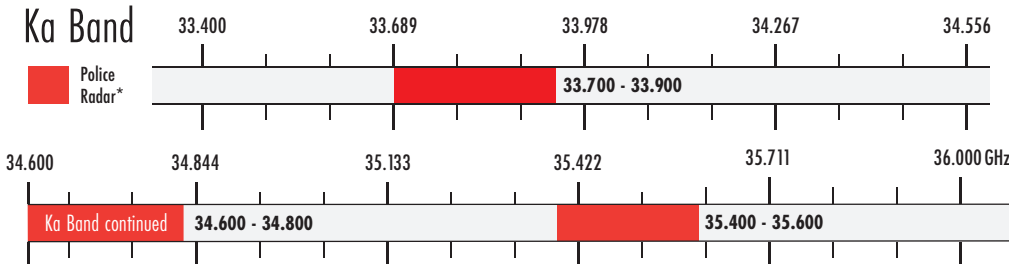

*As police radar guns age or lose calibration, their frequency may drift out of the expected ranges shown.

SAVVY®

This module (optional) lets you reduce the urgency of V1 Gen2's audio warnings at low speeds.

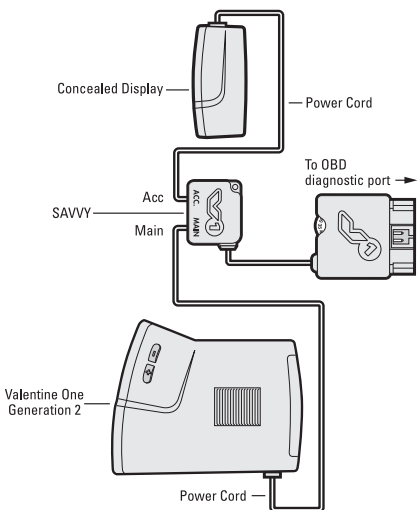
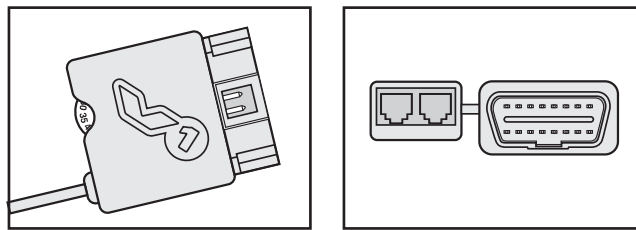
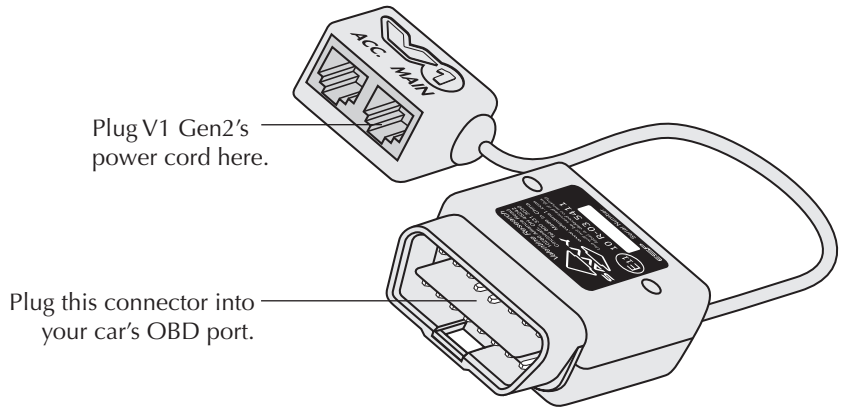

Installation

SAVVY serves as the power source for V1 Gen2, replacing the Lighter Adapter or, in hard-wired installations, the Direct-Wire Power Adapter. Simply plug SAVVY into the OBD (on-board diagnostic) port. Look for it near the steering column at the bottom of the dash or just behind the dash skirt, sometimes under a dust cover. This port has been required on all new cars built since January 1, 1996.

Plug V1 Gen2's power cord into the RJ11 jack labeled "MAIN." To use with the Concealed Display, see the wiring diagram on this page.

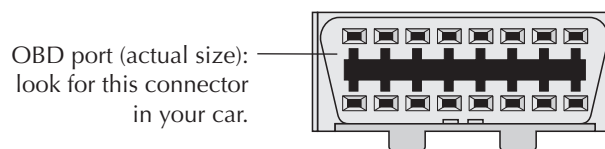

First SAVVY Boot-Up

When the engine is switched on for the first SAVVY boot-up, there will be a “get acquainted” sequence with the car’s electronic system. Up to 30 seconds may be required before V1 Gen2 powers up. On subsequent start-ups, V1 Gen2 will power up within a few seconds.

When the engine is shut off, V1 Gen2 will power down within 10 seconds in most vehicles. Exceptions are rare, but a few vehicles may require up to 5 minutes to complete the shut off.

When SAVVY is removed from the OBD port, it will forget what it knows about the car. This means that the “get acquainted” sequence will be repeated after the next installation even if SAVVY is plugged back into the same car.

Settings

Use the thumbwheel for all settings. The numbers 15 through 65 represent threshold speeds in mph. At speeds below the threshold you’ve set, V1 Gen2’s audio warnings will briefly sound at the Initial Volume before changing to the Muted Volume (see how to adjust on page 6). Above the threshold, V1 Gen2 will sound at its Initial Volume.

On a radar alert that SAVVY muted because your speed was below the threshold, or you muted by tapping the Control Button, volume will automatically unmute when speed rises slightly above your setting.

The AUTO setting brings all alerts in at the Muted Volume regardless of speed. The NONE setting disables SAVVY’s muting function.

Driving with SAVVY

We suggest 30 or 35 mph as an initial setting. After some experimentation, we think most users will find a setting that works for all occasions. The out-of-the-way location of the OBD port is inconvenient for adjusting the thumbwheel, but very good as a starting place for hard-wire installations. For your convenience, two wire clips and a beaded tie strap are included to secure the wire in a safe location away from the pedals.

V1 Gen2 Is Still V1 Gen2

Whether SAVVY mutes a new signal or you do it manually, V1 Gen2’s response is the same; a brief reminder of your current Mode will appear in the Bogey Counter as the new alarm is being muted.

Interactions You Should Know About

- SAVVY draws a small current from the car battery even with the ignition switched off. Use caution in vehicles with weak batteries, or that go for long periods without being driven.
- Some vehicles may not be compatible with SAVVY. Refer to http://www.valentine1.com/savvy/savvy_problem_cars.asp for a list of cars with known issues.

POP Mode

How the POP Mode Works

The POP Mode is a feature of certain radars made by MPH Industries. Its only purpose is to defeat radar detectors. It works by transmitting radar in a short burst—only 67 milliseconds (that’s 0.067 seconds).

What You Should Know About POP Mode

It is inaccurate. In order to outfox detectors, MPH Industries has pushed the technology outside the accepted principles of engineering. The company admits as much when its Operation and Service Manual advises users as follows:

“A note of caution: Information derived during the POP burst is non-evidential...Citations should not be issued based solely on information derived from the POP burst.”

Nonetheless, POP Mode is a reality and it will be used at the discretion of individual enforcers.

Valentine One Gen2 Has Full-Time POP Protection

There is nothing you must do to activate POP coverage. It’s built in, and it operates full time. It covers POP on two bands—specifically the MPH Industries models Bee III and Enforcer on both K and Ka.

What the “Dee-Dah-Doo” Tone Means

Valentine One Gen2 is designed to recognize—and ignore—phony POP signals transmitted by poorly-designed detectors. Occasionally an alarm will be initiated before verification is certain. If it’s then determined that the source is a junk detector, it will notify you it is retracting that alert with a “Dee-Dah-Doo” sound. A flashing J (J) indicating “junk” will appear briefly in the Bogey Counter.

What you should know about radar

How Traffic Radar Works

Traffic radar uses a radar beam to measure speed. Think of the beam as a searchlight. It's invisible because it's made of microwaves instead of light, but otherwise it acts very much like a light beam. It travels in straight lines. It's easily reflected. It scatters as it is passed through dust and moisture in the air. And—this is essential—it has to hit your car before it can determine your speed.

Radar can't see around corners or through hills. It can't see you when you are behind another vehicle. When in the clear, how strongly your vehicle reflects determines how far the radar can read your speed. Generally, larger vehicles reflect more strongly than smaller vehicles. Trucks are "visible" on radar farther away than cars.

The principle on which radar operates is absolutely reliable. Radar equipment, on the other hand, is only as good as the quality of its design and manufacture. Traffic radars tend to be unreliable. They're cheaply made and therefore vulnerable to many interferences that cause false readings. And, compared to the military and weather radar which have rotating antennas, traffic radars are vastly simplified. This simplification means that traffic radar cannot tell one car from another. The operator has to do that, and since the operator can't see an invisible beam any better than you can, he frequently doesn't know which vehicle's speed is being read. This is a source of many undeserved tickets.

How Radar Detectors Work

A radar detector works like a radio tuned to microwave frequencies. Valentine One Gen2 is an extremely sensitive radio, and it's tuned exactly to the frequency bands used by all traffic radar in the U.S.: X band, K band (which includes photo) and Ka band. Moreover, it has two antennas, one aimed forward and one rearward, so that it can locate the radar.

Because Valentine One Gen2 is so sensitive, it can easily find radar from the scattering of the beam, and it can find these scatters a long time before the actual beam hits your car. The only exception is instant-on radar.

How Instant-on Radar Works

As a defense against detectors, many radar units can be operated in the instant-on mode. This means the radar is in position, but it is not transmitting a signal so it cannot be detected. When the target is within range, the radar operator switches on the beam and the radar calculates the speed, usually in less than a second. This calculation happens too quickly for the target (you) to respond in time.

Still, you can defend against Instant-on by recognizing it when the operator zaps traffic ahead of you. Valentine One Gen2's great sensitivity—and your attention to the nuances of its warnings—gives you at least a sporting chance.

The Difference Between X Band and the K Bands

X-band alerts (“Beep”) are often found at long distances. K and Ka bands are usually detected at closer range, and alerts on Ka are much more likely to be radar. So Valentine One Gen2 makes a different sound (“Brap”) to warn you of these more urgent threats (bogeys).

What the Bogey Lock Tone Means

Valentine One Gen 2 is designed to track multiple threats. During an alert, when Valentine One Gen 2 locks on to an additional bogey, it notifies you with the Bogey Lock tone (“Dee-Deet”). This sound will never be heard at any other time, not even during the power-on ritual. Whenever you hear this sound, it means that another bogey has been detected and is being tracked. The bogey counter shows the number of bogeys being tracked at that time.

What Are False Alarms

Since all radar detectors are simply radios tuned to the microwave frequencies used by traffic radar, they automatically sound an alert whenever they encounter signals on those frequencies.

The problem is, other devices that are not radar are also operating on radar frequencies. A detecting radio must respond to them, too. Every response indicates a threat, a bogey. How can you tell the difference between radar and what people commonly refer to as false alarms? Your judgment is the only way. Here are the basics:

- **X band:** A catch-all band, still used regularly in some areas by traffic radar, but heavily populated by sensors for supermarket automatic doors and other nuisance signals. In shopping areas, expect door sensors. But know the territory. Unless you're sure that X band is not used locally for radar, stay alert until you've identified the bogey.
- **K band:** Maybe radar, maybe not. Many new cars have lane-change warning systems that operate on K. Supermarket door openers are usually on K. Another non-radar source—cheapie radar detectors that pollute by transmitting on K.

Identifying Alarms From Junk Detectors

Here are a few clues for spotting offending detectors. You may get a brief K warning just as you meet an oncoming car. Or a lingering K, nearly constant strength, as you move with traffic. Big hint: a direction change on the Radar Locator as you pass another car. Look for a detector in the windshield. But stay alert until you know for sure. See page 16 for what "Dee-Dah-Do" tone means.

- **Ka band:** Watch out! Most of the new-tech radars operate on Ka. Expect some contamination from cheapie detectors, just as with K (clues above also apply to Ka). Do not dismiss Ka alerts until you've positively identified the source.

How To Identify Bogeys

Look first at the Radar Locator. If it points to the side, the bogey is non-threatening—radar can't get you from the side. If the Locator points ahead or behind, try for visual identification. When the Locator changes from Ahead to Beside and then Behind, you can be sure the bogey is safely behind you.

Check the Bogey Counter. Many non-radar devices occur in multiples. For example, most microwave door sensors have at least two transmitters (for In and Out). Often such an installation will have multiple doors, too, so there will be many transmitters. When you see two or more on the Bogey Counter, and particularly when you see it counting up quickly to four or more, you've likely found a nest of door sensors.

Burglar-alarm microwave sensors are often multiples, too, because a single transmitter is not enough to safeguard an entire building. However, microwaves from alarms are less likely to leak out of buildings. So alarms may appear singly or in low multiples.

Single bogeys must be regarded as threats until you see them or put them safely behind you.

Remember, too, that radar beams are easily reflected. Buildings, overhead signs and passing traffic are all good reflectors. When you have a strong signal from one direction, don't be surprised if the Radar Locator shows brief flickers from another direction also as you drive by reflectors.

And never forget that a brief alert, acting alone, may be Instant-on radar zapping other traffic.

Finding Radar

On-the-Road Situations

Valentine One Gen2 gives you far more information about radar than any other radar detector. Still, to achieve the best defense, you must interpret this information correctly. The following examples will help you get maximum protection.

Situation 1: You are driving toward a radar aimed at you.

Your Warning: The Ahead arrow will glow. The Bogey Counter will show 1. You'll hear a slow Beep for X band or Brap for other radars. As you come close to the radar, the Beeps or Braps will become more frequent until they merge into a continuous tone. By this time, you should see the radar.

The Beside arrow and then the Behind arrow will glow as you pass the radar.

In this situation, moving radar and stationary radar will give the same alert, except the Beep rate will increase faster with moving radar because the closing speed is greater.

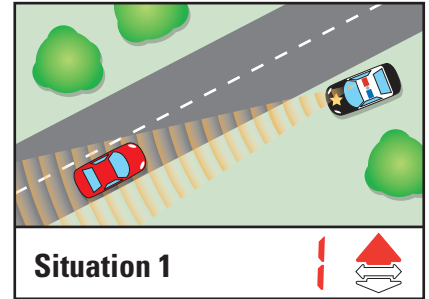

Situation 2: You're driving on a hilly road. Radar is waiting over the next hill.

Your Warning: Well before you reach the hilltop, the Ahead arrow will glow. The Bogey Counter will show 1. You'll hear a slow Beep or Brap, and the rate will increase very quickly as you near the hilltop. As soon as you can see over the hill, you will probably spot the radar.

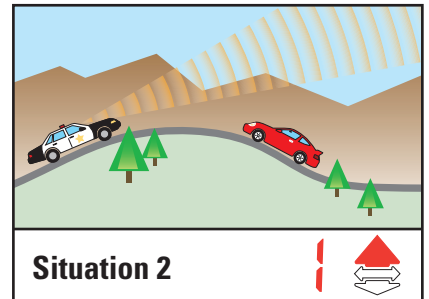

Situation 3: You're driving on a curvy road. Radar is waiting around the next curve.

Your Warning: The Ahead arrow will glow because the radar is forward, not to the side, of your car. The Bogey Counter will show 1. You'll hear a slow Beep or Brap, and the rate will increase very quickly as you turn the corner. You should see the radar as soon as you're around the corner.

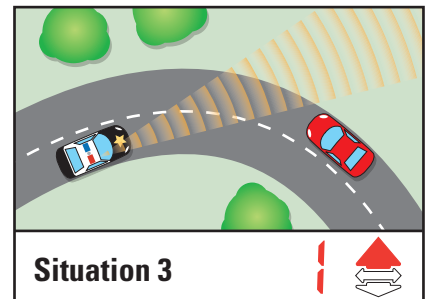

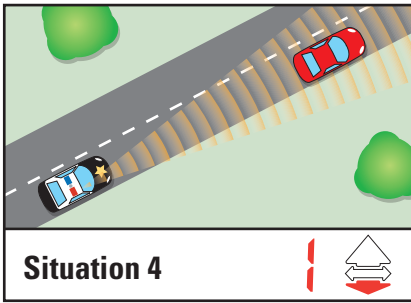

Situation 4: You're driving down the highway and moving radar is coming up behind you.

Your Warning: The Behind arrow will glow. The Bogey Counter will show 1. You'll hear a slow Beep or Brap, and the rate will increase very slowly. This sort of alert could last for miles because the closing rate is just a few mph. Finally, if you watch your mirrors, you'll see the radar. To mute the audio at any time, press the Control Button.

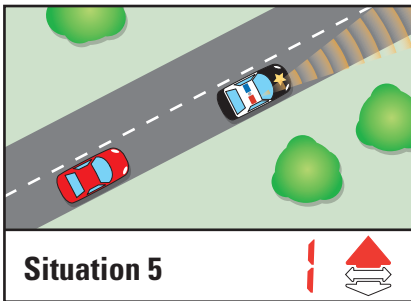

Situation 5: You're driving down the highway and closing on a moving radar ahead of you that's going in your direction.

Your Warning: The Ahead arrow will glow. The Bogey Counter will show 1. You'll hear a slow Beep or Brap that increases very slowly. As in Situation 4, your closing rate is very slow, so this alert could last for a long time.

Whenever you encounter an alert that lasts for an abnormally long time, it's probably radar moving along at about your speed. To mute the audio at any time, press the Control Button.

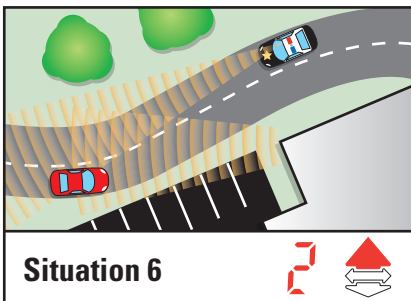

Situation 6: You're driving a route where you expect a burglar alarm, but this time there's radar hiding under the cover of the normal alert.

Your Warning: The Ahead arrow will glow. You'll hear the usual Beep or Brap if you detect the burglar alarm, possibly (but not necessarily) a different sound if the radar is detected first. But when you hear the Bogey Lock ("Dee-Deet") warning, that's a sure indication that this situation is more threatening. The Bogey Lock warning is given whenever Valentine One Gen2 locks onto an additional threat. In this case, the Bogey Counter will show 2, confirming the second threat. If the radar is X band, same as the burglar alarm, you will hear a slow Beep; it may strengthen faster than normal. If the radar is on one of the other frequencies, the audio will correspond to the bogey that the internal computer has determined to be most dangerous.

The key thing to remember is that any time you detect more bogeys than normal, watch out.

Situation 7: You're driving through a metro area with the usual number of burglar alarms and microwave door openers.

Your Warning: Because these signals are usually weak, you'll get slow Beep or Brap (if you hear Bra-Brap, the warning for Ka band, it's probably radar). The Ahead arrow will quickly pass to the side. Or your first alert may be to the side. These alarms are usually located well off the road.

You may also encounter overlapping alarms. During an alert, you'll hear Bogey ("Dee-Deet") Lock each time an additional bogey is detected. The Bogey Counter shows the total, which, in the case of overlapping alarms, will be 2 or more. If they are in different directions, more than one direction arrow will glow. When multiple directions are being monitored, the computer will decide which is most dangerous and that one will be indicated by a flashing arrow. The audio warning will correspond to that bogey.

The key thing to remember about non-radar alarms on X band is this: they're weak and they pass to the side quickly. If you find a strong one Ahead, it's probably radar.

You can minimize the annoyance of these X-band alarms by selecting Logic® or Advanced-Logic® modes. See Controls and Functions on page 4.

Situation 8: You're driving down the highway and Instant-on radar is operating nearby.

Your Warning: The first thing you'll notice will be "Beeeee" or "Braaaaa" because the radar encounter will start instantly at high strength. If the radar is ahead, then the Ahead arrow will glow. Probably the radar is aimed in your direction, but maybe not. It might be aimed the same way you're going, zapping oncoming cars as they approach and ready to shoot you in the back after you've passed. In either case, watch out.

If the Behind arrow glows simultaneously with the "Beeeee" or "Braaaaa", probably you are being shot in the back.

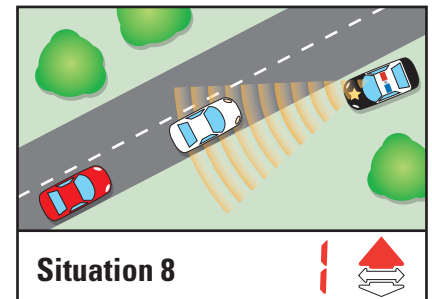
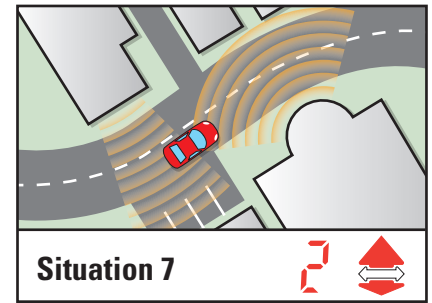

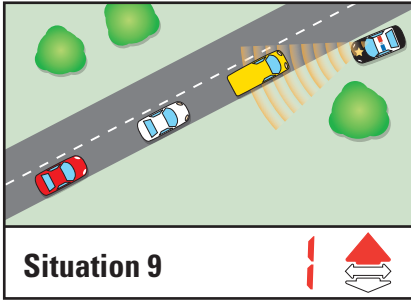

Situation 9: You're driving down a highway and Instant-on radar—a long way ahead—is zapping traffic as it passes.

Your Warning: The Ahead arrow will glow. The Bogey Counter will show 1. You'll hear a very slow Beep or Brap that will last just 3-5 seconds. Then the alerts ends.

What happens next depends on traffic and terrain. If there's light or medium traffic between you and the radar, you'll hear the same pattern again, maybe repeated several times, as the radar zaps each car ahead in turn. If you hear this pattern, watch out.

If there's no traffic within sight ahead, watch out, because you could be next.

With ordinary detectors, short, weak alerts are usually shrugged off as false alarms, leading the motorist to drive right into an Instant-on trap. The Radar Locator is critical to your defense in this circumstance. If it points off to the side, the bogey is not a threat. But if it points ahead, watch out.

How Photo Radar Works

Unlike ordinary radar traps—ambushes hidden within terrain contours—photo radar operates out in the open, usually mounted on a pole, in a roadside box, on a trailer or in a van parked along the road.

Instead of hiding, photo radar uses transmission patterns and sometimes a low-power beam that it angles across the road to reduce the range at which it can be detected. So warning range is short, too short if you have a weak detector. Valentine One Gen2 readily detects photo radar. Ka photo radar will be reported for what it is, a weak signal. K band photo radar will be identified as photo with a "P" in the bogey counter and an audio "Da-Da-Dat" sound after you enable it in the app. Without photo radar enabled, K band photo radar may be missed or reported as a normal K band signal. All bogeys, even weak ones, should be identified before they are dismissed.

Laser Warning

How To Mount

Follow mounting instructions on page 5. Laser Warning requires more care in mounting. Remember that laser is infrared light, and the light path to Valentine One Gen2 could be blocked by certain materials that are transparent to radar. Consider:

1. Important: Position Valentine One Gen2 so that it's level and pointed straight ahead.
2. Avoid locations blocked by wipers or windshield stickers. Make sure glass is clean.
3. Some windshields have a dark tint band across the top. Avoid mounting behind that band.

How To Recognize A Laser Encounter

On laser contact, your warning will be:

1. European two-tone siren warning sound.
2. When Ahead-arrow lights, laser is ahead. When the Behind-arrow lights, laser is behind.
3. Bogey counter displays three horizontal bars.
4. Strength-indicator bar graph shows full strength.
5. Band ID indicates laser.

NOTE: The same visual warnings will be seen on the optional Concealed Display (below).

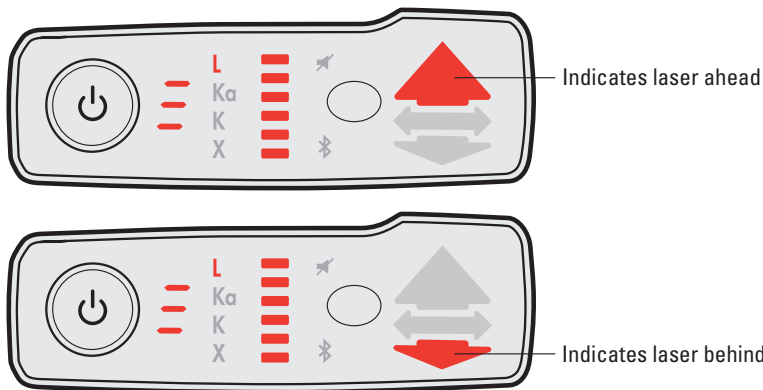

What you should know about laser

How Traffic Laser Works

To measure speed, traffic laser sends out a beam of pulsed infrared light. The beam is tightly focused: at a range of 1000 feet, it's only about four feet wide.

Infrared is invisible to the naked eye—the operator can't see it and neither can you. But it is light and it behaves accordingly. It travels in straight lines. And it's easily reflected.

Traffic laser works as a rangefinder. It sends a pulse, then waits for the reflection from the target car. From the time needed for the pulse to go out and back, and from the speed of light, it calculates distances to the car. These pulses are sent frequently, up to 500 times a second. The changing distance to the target over time is speed.

Laser can't see over hills or through opaque objects. The laser beam must hit your car directly, line-of-sight from the laser gun, to measure speed. Under ideal conditions, it can read speed in less than one second.

The pencil beam means that, in operation, laser is very different from radar. Radar cannot single out one vehicle in a pack, so the speed reading is usually attributed to the leader. The narrow laser beam reads only the vehicle it strikes.

How Laser Detectors Work

A laser detector is an electronic sensor calibrated for the infrared wavelength used by traffic laser. It is extremely sensitive. And it responds in as little as .006 seconds.

It should be mounted inside the car with the sensor facing through the glass toward the laser. When the beam, or scatter from the beam, strikes the detector, it warns instantly.

Finding Laser

How It Operates

Laser's narrow beam imposes significant limits on its use. It must be deliberately and carefully aimed. The operator can't be moving. He must have a clear shot, preferably not through glass, but through glass is possible.

So, laser traps are always ambushes. The operator lies in wait. As with radar, he can't read speed from the side. He must have oncoming and departing traffic. Look for a cruiser angled to the road, or broadside. Watch overpasses and entrance ramps. He will likely rest the laser gun on a partially-down side window to steady his aim. He will pick off traffic as it comes. Or goes.

Our breakthrough Compound Parabolic Concentrator enables Valentine One Gen2 to achieve both wide-angle coverage and unmatched sensitivity. Even so, the over-hills and around-curves warning you expect from a radar detector is not possible with laser. A laser warning requires immediate response.

Details To Remember About Laser

1. There is no moving laser.
2. All laser encounters are like Instant-on radar; virtually no advanced warning.

Laser False Alarms

1. Red neon, from stores and occasionally from brake lights of other cars (example: Chevy TrailBlazer, GMC Envoy, Olds Bravada and Buick Rainier), can imitate the characteristics of speed laser.
Solution: Move away from source.
2. The electrical systems of some cars generate electromagnetic interferences, triggering laser alerts. How to test: Try V1 Gen2 in a different car.
Possible solution: Try relocating detector within the interfering car; also, your dealer may have a factory fix.
3. Adaptive cruise control systems using laser may cause laser alerts.
Solution: Switch to normal cruise control when possible.
4. See <https://www.valentine1.com/v1-info/about-laser-detectors/laser-detector-false-alarms/> for additional laser false alarm sources.

Troubleshooting

Problem	Cause	Solution
Seems dead, no display or audio.	No power.	<ol style="list-style-type: none">1. Check power-cord connections. Check fuse in Lighter Adapter (Is it in place? Is it blown?). See page 9 in Owner's Manual.2. Check contact of Adapter in lighter socket.3. Make sure power is available at lighter socket. Does the lighter work? If not, check fuse in car lighter circuit.4. Try another power cord.5. Make sure the power cord to V1 Gen2 is plugged into the Main jack of the Lighter Adapter.6. Check pins of V1 Gen2's power jack (bent?).
Concealed Display seems dead.	No communication with V1 Gen2.	<ol style="list-style-type: none">1. Try different connecting cords; each must have four conductors.
Sounds the power-on audio when you go over a bump.	Bad power connection.	<ol style="list-style-type: none">1. Make sure Lighter Adapter has good electrical contact.2. Check condition of power cord.3. Lighter socket may be faulty (common in rental cars).
Alerts when you use vehicle accessories, turn signals, brakes, etc.	Electrical problem in your car.	<ol style="list-style-type: none">1. See your mechanic.
Weak or no radar detection.	Possible installation problem.	<ol style="list-style-type: none">1. Make sure front and rear antennas are unobstructed.2. Make sure V1 Gen2 is approximately level.3. See page 5 in Owner's Manual.
Display shows an error (E).	Internal Error	<ol style="list-style-type: none">1. Switch the V1 Gen2 off and back on.2. Contact the service department if the E display persists.

Troubleshooting

Problem	Cause	Solution
Weak detection in front but good behind. Directional arrows are inaccurate.	Possible installation problem.	1. Make sure your windshield is not covered with a metallic film (some cars have them for de-icing or as a solar barrier).
Numerous false alerts.	Other super-heterodyne radar detectors mounted in the same vehicle.	1. Do not operate V1 Gen2 in close proximity to other detectors.
Display is “frozen” with all lights on.	V1 Gen2 is inadvertently in the program mode.	1. Replace power cord. If using Concealed Display, make sure Mute button is not depressed.
Characters in the display that you don’t recognize.	V1 Gen2 is in mode unfamiliar to you.	1. Press and hold Mute button to change modes. See page 4 in Owner’s Manual.
Can’t change modes.	Faulty power cord.	1. Replace power cord.
False X-band alert from rear, either continuous or random intervals.	Cell-phone interference.	1. Relocate V1 Gen2. 2. Change modes to Advanced-Logic (L). 3. Change cell-phone service provider.
False Ka-band alert from rear.	Satellite radio interference.	1. Relocate radio antenna.
False laser alerts, either continuous or random intervals. See page 27 in the manual or https://www.valentine1.com/v1-info/about-laser-detectors/laser-detector-false-alarms/ .	Laser cruise control; in-dash navigation screen; rain-sensing wipers.	1. Switch to normal cruise control instead of laser. 2. Relocate V1 Gen2 so laser sensor is not pointed toward navigation screen or rain sensor for the wipers.

Doubts . . . Maybe it's not working right

You bought Valentine One Gen2 because you wanted the best radar protection. When you're really concerned about having the best, doubts come easily . . . "Is it really working right?" . . . "It didn't give much warning that time. Is it dying on me?"

Such doubts are not easily resolved by a few paragraphs in a Manual. Still, radar behaves according to laws of physics. So does Valentine One Gen 2. There are reasons for everything that happens. Please consider the following possibilities:

1. If you didn't get a radar alert from a patrol car, was the radar turned on? Remember that Instant-on doesn't send out a detectable beam until it's triggered.
2. There are strong radars and weak ones. If you received a weak alert, could it have been a kind of radar that you're not used to?
3. The radar antenna can be pointed any direction inside the radar car. It doesn't have to point toward the front. Are you sure it was pointed at you? If it's pointed away, its strength as you approach is much less.
4. Traffic, particularly trucks, between you and the radar can block the beam. Were you blocked?
5. The radar beam travels in a straight line. Was there a hill or building blocking the beam?
6. Rain, moisture, or dust in the air can shorten radar range. Could this be the reason for the weak alert?

Valentine One Gen 2 was designed to provide you with security. We don't want you to have doubts. If you still feel that your unit is not operating properly, call us at 800-331-3030. You can discuss your doubts with a technical expert who'll help you decide if your unit should be sent in for service.

Service

If Your Valentine One Gen2 Needs Repair:

Before sending your Valentine One Gen2 back to us for service, please check TROUBLESHOOTING on pages 28-29.

If it's completely dead, make sure it's connected to a reliable power source. Try another car.

If it still fails to function, follow these instructions to obtain factory service.

Where to Ship:

Return your Valentine One Gen2, both power cords and lighter adapter (don't send the mounts) to:

Valentine Research
Customer Service
10280 Alliance Road
Cincinnati, Ohio 45242

How to Ship:

Ship your Valentine One Gen2 in its original packaging or something equally protective.

Along with your Valentine One, please enclose a completed Service Form, which can be found at <https://www.valentine1.com/service-form>.

Your Valentine One will be repaired quickly and returned to you.

For units that have been abused or modified, a repair cost will be calculated based on parts and labor required. You will be contacted if the repair cost exceeds the charge listed on the Service Form.

NOTES: 1. We will not repair any Valentine One Gen2 that has an unreadable serial number.

2. We ship to addresses within the USA, Puerto Rico, or Canadian Provinces AB, BC or SK only.

Prices subject to change without notice.

Upgrades

The upgrade process is conducted entirely online. Please go to <https://www.valentine1.com/v1-detectors/upgrades/>.

Specifications

Operating Frequencies:	10.500–10.550 GHz (X band) 24.050–24.250 GHz (K band) 33.400–36.000 GHz (Ka band) 13.400–13.500 GHz (Ku band): Not used in U.S.—to activate Ku band, https://www.valentine1.com/programming/ 820-950 nanometers (Laser) 2.4000-2.4835 GHz (Bluetooth), RF Output Power: 0 dBm
Power Requirements:	6.0-35.0 Volts DC negative ground 2.8 watts typical standby, 5.2 watts maximum alarm condition
Dimensions and Weight:	4.6 in. L x 3.8 in. W x 1.0 in. H; 6.5 oz. 117 mm L x 96 mm W x 25 mm H; 180 g
Temperature Range:	Operating: -20°C to +70°C (-4°F to +158°F) Storage: -30°C to +85°C (-22°F to +185°F)

Parts and Accessories

The following items and more are available in **Our Store** at www.valentine1.com. Or call toll-free **1-800-331-3030**.

Click on Defense Gear for:

- Tech Display** enables operation of V1 Gen2 with lights being visible to driver only and informs you of the radar frequency of the most threatening source.
- SAVVY** lets you reduce the urgency of V1 Gen2's audio warning at low speeds. Works with most 1996-and-later cars. See <https://www.valentine1.com/v1-detectors/savvy/savvy-problem-cars/> for cars with compatibility issues.
- Concealed Display** enables operation of V1 Gen2 with lights being visible to driver only.
- Carrying Case** tough, molded half-shells for protection, zip closure.

Click on Parts Dept. for:

- USB Power Adapter** powers Valentine One Gen2 from car's USB socket.
- Lighter Adapter** powers Valentine One Gen2 from car's lighter socket.
- Direct-Wire Power Adapter** powers Valentine One Gen2 directly from car's wiring.
- Fuses** replacement for Lighter Adapter: 2 amp Mini Blade Fuse (Littelfuse 297002) replacement for Direct-Wire Power Adapter: 2 amp Mini Blade Fuse (Littelfuse 297002).
- Wiring-harness connector** provides simple, safe attachment to ignition wiring using ordinary hand tools.
- Power cords** coiled, 1 ft. stretches to 6 ft.
coiled, 2 ft. stretches to 8 ft.
straight, 3.5 in.
straight, 8 ft.
- Windshield mount** suction-cup mount with one-touch adjustment for windshield angle and release from windshield.
- Visor mount** mount with spring clip for quick installation on visor.
- Suction cups (4)** replacement cups for use with mount.
- Self-stick interlocking fasteners** extra fasteners for Concealed Display and power adapter.

Valentine One Generation 2 is a trademark of Valentine Research, Inc. | SAVVY is a registered trademark of Valentine Research, Inc. | Bluetooth is a registered trademark of Bluetooth SIG, Inc. | iPhone, iPad and iPod touch are trademarks of Apple Inc. | Android is a trademark of Google Inc.

Limited Warranty

Valentine Research, Inc. warrants the Valentine One Generation 2 Radar Locator™ against all defects in materials and workmanship for a period of one year from the date of the original purchase, subject to the following terms and conditions.

This warranty is limited to the original owner, and is **Non-Transferable**.

This warranty does not apply if the serial number or housing of the product has been removed, or if the product has been subjected to physical abuse, improper installation, or modification.

To obtain warranty service, the product must be returned insured with shipping prepaid, to Valentine Research, Inc., at the address below, in its original packaging or a suitable equivalent, along with a completed Service Form, which can be found **www.valentine1.com/service-support**.

Valentine Research, Inc.'s responsibility under this warranty is limited to repair or replacement of the product or refund of its purchase price, at the sole discretion of Valentine Research, Inc.

Valentine Research, Inc. disclaims all other warranties, expressed or implied, including warranties of merchantability and fitness for any particular purposes whatsoever, and no other remedy shall be available, including without limitation, incidental or consequential damages. In no event shall Valentine Research, Inc.'s liability exceed the purchase price of the product in question.

Some states do not allow the exclusion or limitation of incidental or consequential damages of how long an implied warranty lasts, so the above limitations or exclusions may not apply to you.

This warranty gives you specific rights. You may have other legal rights which vary from state to state.

Valentine Research, Inc. wants you to be satisfied with its products. Should you have any difficulties with the operation or performance of your Valentine One Gen2 Radar Locator, please contact:

Valentine Research
Customer Service
10280 Alliance Road
Cincinnati, Ohio 45242
800-331-3030

WARNING: USE THIS PRODUCT ONLY IN ACCORDANCE WITH ITS END USER LICENSE AGREEMENT. WATCHING THE SCREEN WHILE YOUR VEHICLE IS IN MOTION MAY BE DANGEROUS. DRIVE SAFELY AND OBEY ALL TRAFFIC LAWS.

USE OF **V1connection, the app** IS SUBJECT TO THE END USER LICENSE AGREEMENT AS APPEARING AT <http://www.valentine1.com/v1info/v1connection/v1connectioneu.pdf>.

CE Hereby, Valentine Research, Inc., declares that this radar detector is in compliance with the essential requirements and other relevant provisions of Directive 2014/53/EC.

Refer to <http://www.valentine1.com/standards> for the Document of Conformity.

FC This device complies with Part 15 of the FCC Rules. Operation is subject to the following two conditions:

- 1) this device may not cause harmful interference, and
- 2) this device must accept any interference received, including interference that may cause undesired operation.

NOTE: The manufacturer is not responsible for any radio or TV interference caused by unauthorized modifications to this equipment. Such modifications could void the user's authority to operate the equipment.

V1connection is a trademark of Valentine Research, Inc. | SAVVY is a registered trademark of Valentine Research, Inc. | iPhone, iPad and iPod touch are registered trademarks of Apple Inc. | Android is a trademark of Google Inc.

Bluetooth is a registered trademark of Bluetooth SIG, Inc. QDID: D038345 and D037292
Contains FCC ID: QJAG2
Contains IC: 109191A-G2

Le présent appareil est conforme aux CNR d'Industrie Canada applicables aux appareils radio exempts de licence. L'exploitation est autorisée aux deux conditions suivantes:

- 1) l'appareil ne doit pas produire de brouillage, et
- 2) l'utilisateur de l'appareil doit accepter tout brouillage radioélectrique subi, même si le brouillage est susceptible d'en compromettre le fonctionnement.

Under Industry Canada regulations, this radio transmitter may only operate using an antenna of a type and maximum (or lesser) gain approved for the transmitter by Industry Canada. To reduce potential radio interference to other users, the antenna type and its gain should be so chosen that the equivalent isotropically radiated power (e.i.r.p.) is not more than that necessary for successful communication.

Conformément à la réglementation d'Industrie Canada, le présent émetteur radio peut fonctionner avec une antenne d'un type et d'un gain maximal (ou inférieur) approuvé pour l'émetteur par Industrie Canada. Dans le but de réduire les risques de brouillage radioélectrique à l'intention des autres utilisateurs, il faut choisir le type d'antenne et son gain de sorte que la puissance isotrope rayonnée équivalente (p.i.r.e.) ne dépasse pas l'intensité nécessaire à l'établissement d'une communication satisfaisante.

NOTE: This equipment has been tested and found to comply with the limits for a Class B digital device, pursuant to part 15 of the FCC Rules. These limits are designed to provide reasonable protection against harmful interference in a residential installation. This equipment generates, uses and can radiate radio frequency energy and, if not installed and used in accordance with the instructions, may cause harmful interference to radio communications. However, there is no guarantee that interference will not occur in a particular installation. If this equipment does cause harmful interference to radio or television reception, which can be determined by turning the equipment off and on, the user is encouraged to try to correct the interference by one or more of the following measures:

- Reorient or relocate the receiving antenna.
- Increase the separation between the equipment and receiver.
- Connect the equipment into an outlet on a circuit different from that to which the receiver is connected.
- Consult the dealer or an experienced radio/TV technician for help.

NOTE: THE GRANTEE IS NOT RESPONSIBLE FOR ANY CHANGES OR MODIFICATIONS NOT EXPRESSLY APPROVED BY THE PARTY RESPONSIBLE FOR COMPLIANCE. SUCH MODIFICATIONS COULD VOID THE USER'S AUTHORITY TO OPERATE THE EQUIPMENT.

A Few Things to Remember

1. Valentine One Gen2 is defined as a radio by the FCC. It receives only. It's a passive device that in no way interferes with the communications or business of others.
2. The Federal Communication Act of 1934 guarantees the right to receive radio transmissions of all types on all frequencies. Traffic radar is not privileged communication: in fact, it's not communication of any sort because no information is conveyed to another party. It is surveillance by radio waves, and that is not protected by any laws.
3. Some states and municipalities have laws prohibiting the use, or the possession, or both, of radar detectors. Please check local regulations before using your Valentine One Gen2.
4. Leaving your Valentine One Gen2 in plain sight in an unattended car is asking for a break-in.

We appreciate your confidence in Valentine Research.

Please drive safely.

For Your Records

Serial No.

Purchase Date

Manufactured under the following U.S. patents:

11,474,198
10,585,168
10,514,441
10,488,490
9,658,319
8,478,223
7,579,976
7,450,051

Download this Manual at: v1gen2.info/manual



w w w . v a l e n t i n e 1 . c o m

Download this Manual at: **v1gen2.info/manual**



Valentine Research

10280 Alliance Road
Cincinnati, Ohio 45242
513-984-8900
800-331-3030